



Biological Microscope  
**ECLIPSE**  
**E200**

# Features exceptionally bright and uniform LED illumination and Nikon's high-quality optics. Ergonomic and anti-mold design ensures years of comfortable and stable use.

This compact small-sized clinical and laboratory microscope uses newly developed high-intensity LED illumination. The long-life LED illuminator is environmentally friendly as it reduces the need for frequent lamp replacement. A halogen illumination model is also available.

The ECLIPSE E200 uses Nikon's CFI60 optical system—highly-acclaimed infinity corrected optics used in Nikon research microscopes. The result is stunningly sharp and clear images with less chromatic aberration. A variety of specimens can be observed with the ECLIPSE E200, thanks to its compatibility with many accessories made for higher-grade ECLIPSE series microscopes.

With the ECLIPSE E200, Nikon has designed a simple and easy-to-use system that reduces fatigue from use over long periods. With a robust structure and anti-mold design, the ECLIPSE E200 offers high quality and accuracy that can be retained for years even in hot and humid environments.

The ECLIPSE E200 offers exceptional operability and durability, and high-quality images. It can be used for various purposes, such as educational, clinical laboratory use and basic research.

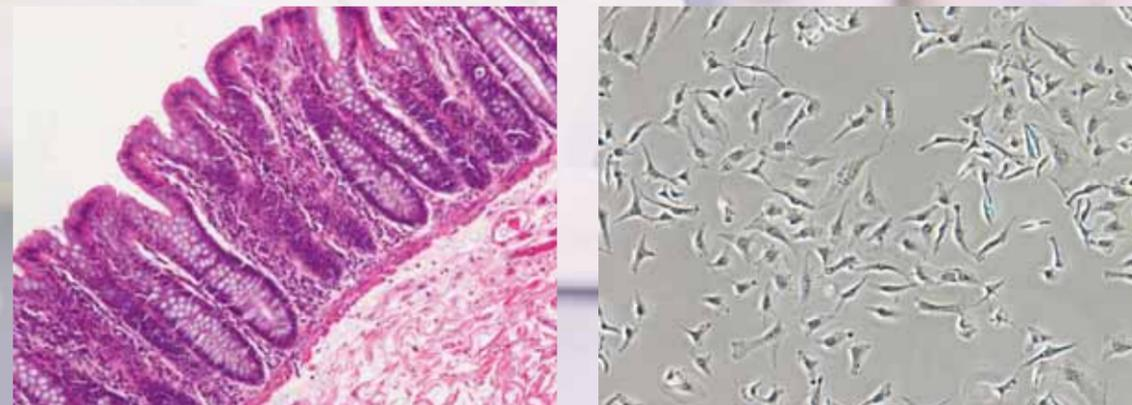

ECLIPSE E200-F (model with field diaphragm)

ECLIPSE E200

## High-intensity LED Eco-illumination

The newly developed Eco-illumination provides enough brightness for both phase contrast observation and simple polarizing observation. With a fly-eye lens in the illumination system, uniform brightness is provided in the entire field of view. LEDs are environmentally friendly, consume less power than halogen lamps, and last approximately 60,000 hours, reducing costs and the need for frequent lamp replacement. The color temperature does not change when magnification is changed. A halogen illumination model is also available.

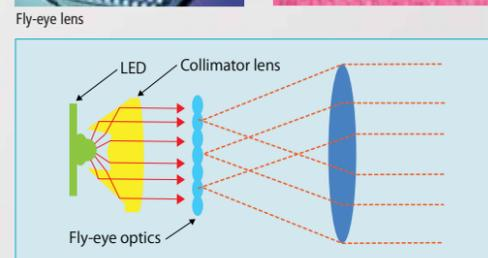

# Superb infinity optics, plus ergonomic touches



## CFI60 optical system

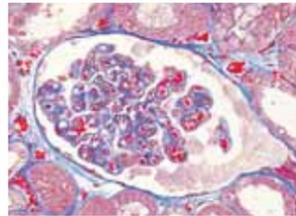
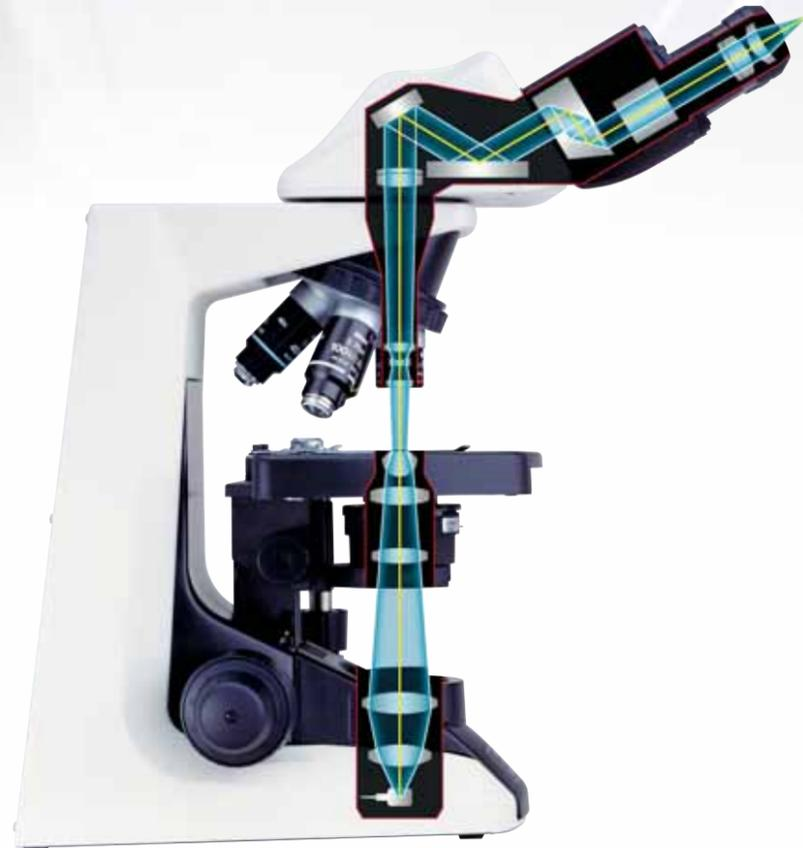

The CFI60 optical system combines Nikon's renowned CF optical design with infinity optics to overcome the limitations of the traditional infinity design. CFI60 optics provide longer working distances and higher N.A.'s. These optics deliver startlingly clear images at any magnification because chromatic aberrations and curvature of field are both corrected over the entire field of view when the field number is 20 mm. Nikon developed dedicated CFI E Plan Achromat objectives exclusively for the E200. Also, you can use other higher-grade objectives available for the ECLIPSE series whenever your laboratory situation calls for it.

### Anti-mold design

Mold is a formidable enemy of microscopes. Before you know it, it can begin growing on the interior optical surfaces of the microscope and ruin performance. Using anti-mold paint, plus anti-mold agent sealed at critical places inside the microscope, the ECLIPSE E200 is designed to resist mold growth. In tests, an anti-mold treated unit was able to resist the growth of mold for three consecutive years at an average temperature of 30 °C (86 °F) and 80 % humidity.

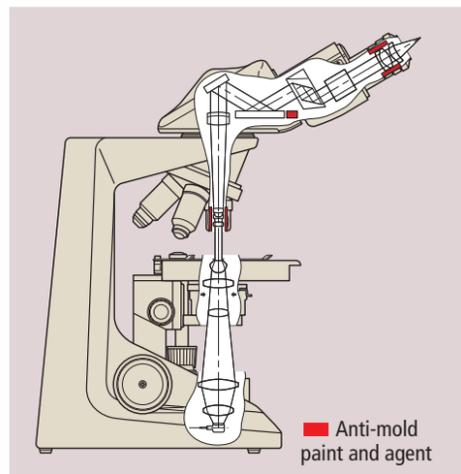

### Ergonomic design equals comfortable operation

Comfort is ensured allowing long hours of use, thanks to Nikon's thoughtful ergonomic design. This is the same design incorporated into Nikon's other laboratory and research-grade ECLIPSE series microscopes.

For example, the focus knob and the stage handle are located equidistant from the operator, permitting one-handed operation in a natural posture without twisting the shoulders. Because these controls are low positioned, you can operate the microscope while resting your arms comfortably on the desk. Moreover, the low-profile stage makes exchange of specimen slides easy, while the low inclination angle eyepiece tube provides comfortable viewing.

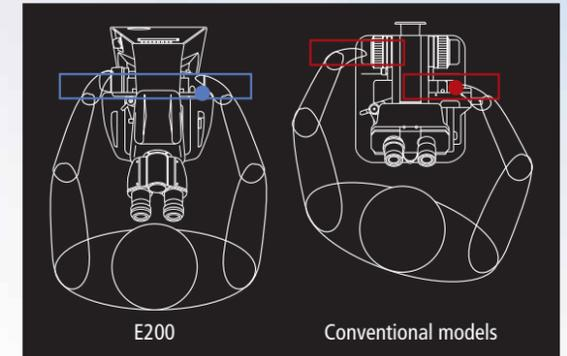

Comparison of the positions of the stage handle and focus control knob

### Ergonomic binocular tube

With this option, users can adjust not only the eyepiece tube tilt angle, but the eyepiece length to suit their build, eliminating discomfort and strain during long hours of observation. A camera can be attached using the DSC port.

\*Use of this accessory in combination with other equipment may produce darker images around the periphery.  
\*Must be attached directly to the main body.



View angle is adjustable by 10° to 30°.



Eyepiece length can be extended by up to 40 mm.

### Eye-level riser

Up to two eye-level risers can be mounted to raise the height of the eyepoint—25 mm each for a total of 50 mm.

### Robust, vibration resistant construction

One-piece construction from arm to base, a stage design where its up/down mechanism is located in the base, plus a wide footprint of 188.5 mm across the back all provide greater rigidity and resistance to vibrations, contributing to superior images.



# Design ideas that ensure superb optical quality and increased ease of use

## CFI60 objectives

Nikon's exclusive CFI60 objectives provide numerous benefits: longer working distances, high numerical apertures, flat images over the entire field of view with virtually no curvature of field when the field number is 20 mm. To match your laboratory requirements, the E200 provides a wide selection of objectives to choose from. These include the CFI E Plan Achromat objectives developed for the E200 or other higher-grade ECLIPSE series objectives.



CFI E Plan Achromat objectives

## Eyeiece tube

The Siedentopf-type eyepiece tube is inclined at 30° to ensure comfortable viewing in a natural posture. Designed for use by operators with different builds, this eyepiece has a narrow minimum interpupillary distance of 47 mm, while the eyepoint height can be raised 34 mm when interpupillary distance is 64 mm by simply swinging the front part of the eyepiece tube up 180°. For extremely tall users, eye-level risers are available to customize the microscope.

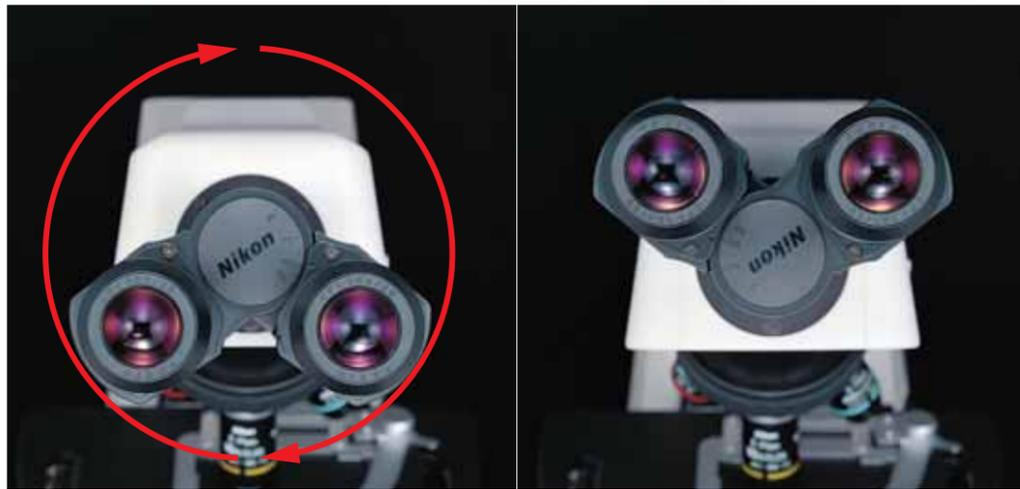

Low position

High position



E2-TB Binocular Tube

E2-TF Trinocular Tube

\*Eyepiece lens is optional.

## Eyepieces

The E200's eyepieces feature a wider field of view for a microscope of this class and are available in 10x (F.O.V. 20) and 15x (F.O.V. 12) types. These eyepieces also feature built-in diopter adjustment that allows the operator to adjust diopters separately for the right and left easily. In addition, these eyepieces accept measuring reticles that will always be in sharp focus with the specimen. Moreover, they can be locked preventing theft and eliminating the possibility of damage during transit.

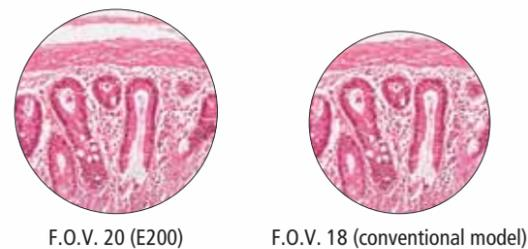

F.O.V. 20 (E200)

F.O.V. 18 (conventional model)

## Refocusing stage

Nikon has created a unique innovation. The Refocusing Stage eliminates the need to refocus the image manually, making specimen handling safer and easier. In this unique design, the stage can be instantly dropped by pushing it down to exchange specimens or oil the slide, then returns to the original position as soon as the hand is removed. The wide stage surface can accommodate two slide glasses at the same time.

In addition, this stage has an array of features including:

- Increased resistance to vibrations due to the design of the in-base focus mechanism
- Low-profile design that creates more space around the objective for increased freedom in specimen handling and easier operation
- A belt-drive mechanism to eliminate the projection of the rack at the edge of the stage for better ergonomics and smoother movement
- Removable specimen holder for fast hand scanning of slides
- Improved XY cross travel, providing the comfort and feel similar to Nikon's higher grade ECLIPSE series microscopes



Wide stage surface with no rack sticking out of the stage

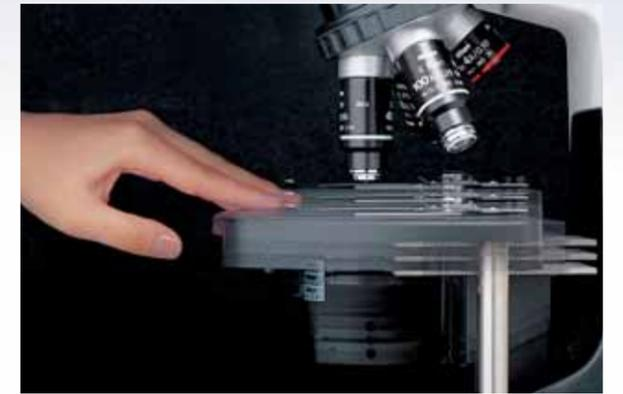

## Upper limit stopper

When using short-working-distance objectives such as 40x or greater, you can set the upper limit of the stage movement, so that the objective doesn't hit the specimen slide, protecting both from damage. Thanks to this feature, even novices or operators who need to change slides often can perform their job easily and quickly. The limit height can be set in two levels using a stopper bolt—either at the standard position or 2 mm lower. This feature is very useful except when extraordinarily thick specimens are used.

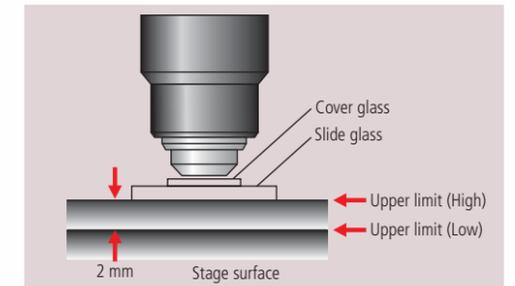

## Revolving nosepiece

A reversed-type nosepiece creates more space at the front of the stage, making handling of specimen slides fast and easy. In addition, the CFI60 optical design eliminates extra optical elements in the nosepiece for enhanced image sharpness. Another advantage of CFI60 objectives is that their increased objective lengths and longer working distances provide more working space around the nosepiece.



# A wealth of accessories to broaden the range of microscopic applications

## Condenser

Although the stage is low-positioned for comfort, there is ample space around the condenser for easy access. The condenser also features an aperture diaphragm that comes complete with position guide markings for respective E Plan objectives to make operation quick and easy.



## Safe and easy halogen lamp replacement

Lamp replacement is now made even easier by simply opening the lens unit cover and replacing the lamp.



## Field diaphragm model available

The E200-F has a built-in field diaphragm that allows the use of Koehler illumination. It features a field lens unit with a field diaphragm that has position guide markings for respective objective lenses to allow easy setting of optimal apertures.

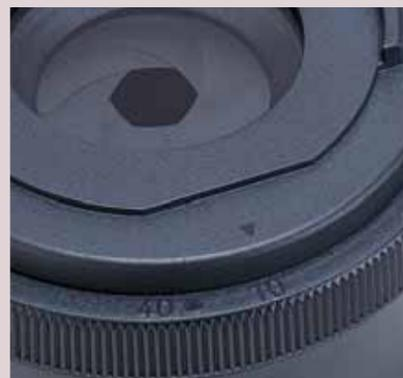

Field diaphragm with position guide markings



E200-F

## Wide variety of condensers

Abbe, phase and other ECLIPSE series condensers, except the universal type, can be used with the E200.



E2 Abbe Condenser (left) and E2 Phase Condenser

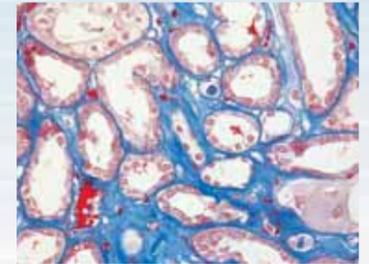

## Phase contrast

Simple phase contrast observation at 10x, 20x and 40x is possible with a single phase annulus slider.

The aperture diaphragm automatically opens when the slider is inserted into the condenser. Phase contrast 100x slider and darkfield slider up to 40x objectives are available as options.

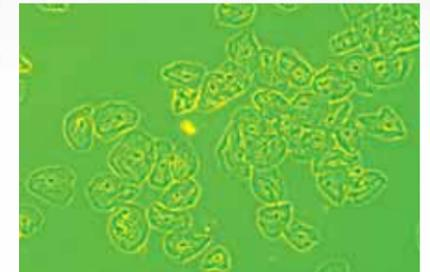

CFI Achromat DL objectives for phase contrast



## Epi-fluorescence

The E200-dedicated epi-fluorescence attachment is available for users who want to begin fluorescence observation. Although affordably priced, this attachment allows comprehensive epi-fluorescence as well as UV excitation observations.



Filters are optional.

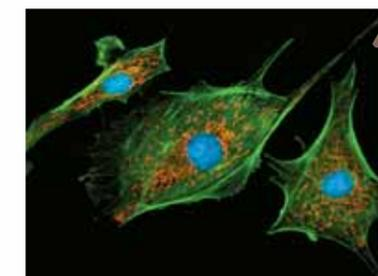

## Simple polarizing

This method is ideal for observing amyloid and crystals. To set up, install the polarizer over the field lens and the analyzer.



Simple Polarizing Set C

# System diagram

## Ergonomic binocular tube



Both eyepiece length and tilt angle are adjustable.

## Eye-level riser

Two risers can be inserted to increase the eyepoint height, 25 mm per riser for a total of 50 mm.



## Teaching heads

Face-to-face\* and side-by-side teaching heads are available.

\*Not recommended for use in conjunction with a photomicrographic system, because it makes the microscope top-heavy.



## Object marker

Allows the point of interest within a specimen to be marked with ink

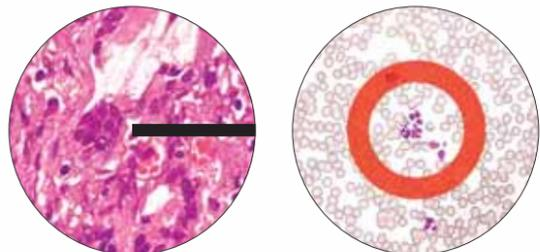

## Drawing tube

Allows accurate sketching of the image being observed



## Digital Sight series camera system

When the trinocular eyepiece tube is used, a digital camera can be attached.\* The DS-Fi2-L3, a color camera head combined with a standalone control unit, enables focusing and viewing of images on the built-in 8.4-inch LCD monitor without the need for a PC.

The optimum imaging conditions that match the observation technique in use can be automatically set by selecting the appropriate "scene mode" icon on the touch panel. Storing optimal images is easy.

\*With a 4x objective lens, the image may show uneven illumination depending on the camera used.



## Plastic storage case

The rugged, lightweight storage case is handy for transporting and storing the E200.



## ND filter for objective lenses (ND3)

When this filter is used in combination with a 4x or 10x objective lens, image brightness can be adjusted to nearly equal to that of a 40x objective lens.

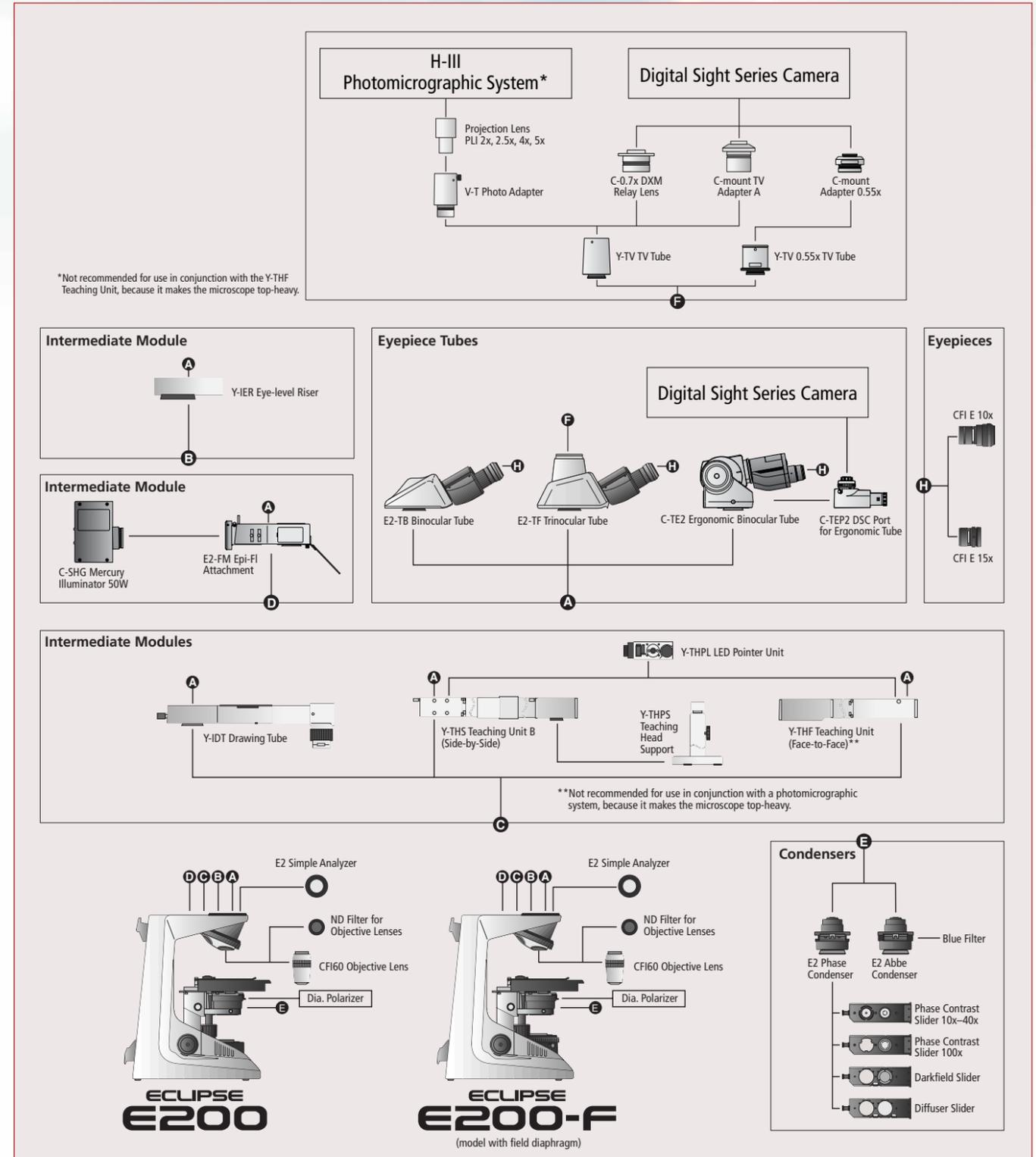

Both LED illumination and halogen illumination models are available.

# Specifications

<b>Main body</b>	
<b>Optical system</b>	CFI60 Infinity Optical System, Parfocal distance: 60 mm
<b>Illumination</b>	High luminescent white LED illuminator (Eco-illumination) 6V20W/6V30W halogen lamp, Compliant multi-voltage (100 V-240 V)
<b>Eyepieces (F.O.V.)</b>	<ul style="list-style-type: none"> <li>• CFI E 10x (20 mm)</li> <li>• CFI E 15x (12 mm)</li> </ul>
<b>Focusing</b>	Coaxial coarse/fine focusing, Right: fine, Left: coarse/fine, Focusing stroke: 26.5 mm, Coarse: 37.7 mm/rotation, Fine: 0.2 mm/rotation, Coarse motion torque adjustable, Refocusing function
<b>Tubes</b>	<ul style="list-style-type: none"> <li>• E2-TB Binocular Tube</li> <li>• E2-TF Trinocular Tube, Eyepiece/Port: 100/0, 0/100, 360° rotatable</li> <li>• C-TE2 Ergonomic Binocular Tube, Inclination: 10–30 degrees, Extension: up to 40 mm</li> </ul>
<b>Nosepieces</b>	Quadruple nosepiece (within main body)
<b>Stages</b>	Rectangular stage (within main body), with specimen holder, Cross travel: 78 (X) x 54 (Y) mm
<b>Objectives (NA / W.D., mm)</b>	<ul style="list-style-type: none"> <li>• CFI E Plan Achromat 4X (0.10 / 30)</li> <li>• CFI E Plan Achromat 10X (0.25 / 0.7)</li> <li>• CFI E Plan Achromat 40X (0.65 / 0.65)</li> <li>• CFI E Plan Achromat 100X Oil (1.25 / 0.23)</li> </ul> CFI Achromat DL and other higher-grade CFI60 objectives can be used.
<b>Condensers</b>	<ul style="list-style-type: none"> <li>• E2 Abbe Condenser N.A. 1.25, Aperture diaphragm with position guide markings for respective CFI E Plan objectives</li> <li>• E2 Phase Condenser N.A. 1.25, Aperture diaphragm with position guide markings for respective CFI Achromat DL objectives</li> </ul> For the model without field diaphragm: C-C Achromat Condenser, Achromat Swing-out Condenser 2–100x, Darkfield Condenser (dry), C-C Phase Contrast Condenser
<b>Observation methods</b>	Brightfield, Epi-fluorescence, Darkfield, Phase contrast, Simple polarizing
<b>Intermediate attachment**</b>	<ul style="list-style-type: none"> <li>• E2-FM Epi-fluorescence Attachment, 2 filter cubes mountable</li> <li>• Y-THS Teaching Unit B (Side-by-Side)</li> <li>• Y-THF Teaching Unit (Face-to-Face)</li> <li>• Y-IDT Drawing Tube</li> <li>• Y-IER Eye-level Riser</li> </ul>
<b>Power consumption (max.)</b>	Normal value: 3 W (LED model), 41 W (halogen model)
<b>Weight (approx.)</b>	7.3 kg (Binocular standard set)

\*Observations except brightfield require optional accessories. \*\*Maximum intermediate space 50 mm

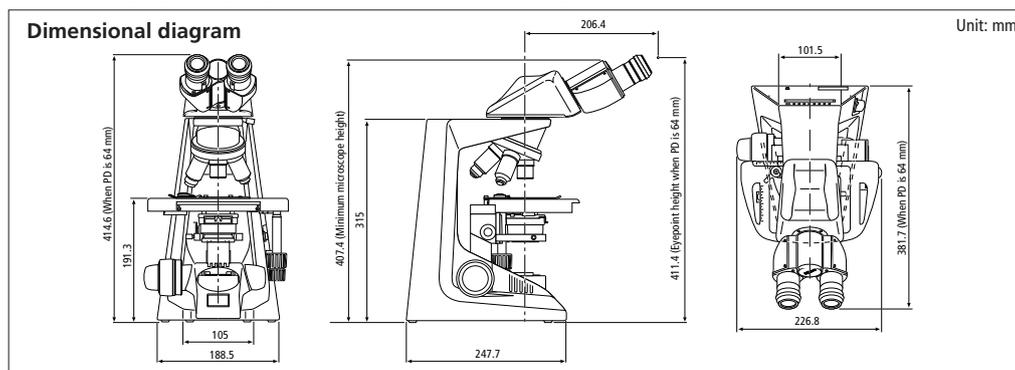

Specifications and equipment are subject to change without any notice or obligation on the part of the manufacturer. November 2011 ©2000-11 NIKON CORPORATION

	<b>WARNING</b>
TO ENSURE CORRECT USAGE, READ THE CORRESPONDING MANUALS CAREFULLY BEFORE USING YOUR EQUIPMENT.	

Monitor images are simulated.  
Company names and product names appearing in this brochure are their registered trademarks or trademarks.  
N.B. Export of the products\* in this brochure is controlled under the Japanese Foreign Exchange and Foreign Trade Law.  
Appropriate export procedure shall be required in case of export from Japan.  
\*Products: Hardware and its technical information (including software)



ISO 9001 Certified  
NIKON CORPORATION  
Instruments Company

ISO 14001 Certified  
NIKON CORPORATION



**NIKON CORPORATION**  
Shin-Yurakucho Bldg., 12-1, Yurakucho 1-chome, Chiyoda-ku, Tokyo 100-8331, Japan  
phone: +81-3-3216-2375 fax: +81-3-3216-2385  
<http://www.nikon.com/instruments/>

**NIKON INSTRUMENTS INC.**  
1300 Walt Whitman Road, Melville, N.Y. 11747-3064, U.S.A.  
phone: +1-631-547-8500; +1-800-552-NIKON (within the U.S.A. only)  
fax: +1-631-547-0306  
<http://www.nikoninstruments.com/>

**NIKON INSTRUMENTS EUROPE B.V.**  
Laan van Kronenburg 2, 1183 AS Amstelveen, The Netherlands  
phone: +31-20-44-96-300 fax: +31-20-44-96-298  
<http://www.nikoninstruments.eu/>

**NIKON INSTRUMENTS (SHANGHAI) CO., LTD.**  
CHINA phone: +86-21-6841-2050 fax: +86-21-6841-2060  
(Beijing branch) phone: +86-10-5831-2028 fax: +86-10-5831-2026  
(Guangzhou branch) phone: +86-20-3882-0552 fax: +86-20-3882-0580

**NIKON SINGAPORE PTE LTD**  
SINGAPORE phone: +65-6559-3618 fax: +65-6559-3668

**NIKON MALAYSIA SDN. BHD.**  
MALAYSIA phone: +60-3-7809-3688 fax: +60-3-7809-3633

**NIKON INSTRUMENTS KOREA CO., LTD.**  
KOREA phone: +82-2-2186-8400 fax: +82-2-555-4415

**NIKON CANADA INC.**  
CANADA phone: +1-905-602-9676 fax: +1-905-602-9953

**NIKON FRANCE S.A.S.**  
FRANCE phone: +33-1-4516-45-16 fax: +33-1-4516-45-55

**NIKON GMBH**  
GERMANY phone: +49-211-941-42-20 fax: +49-211-941-43-22

**NIKON INSTRUMENTS S.p.A.**  
ITALY phone: +39-055-300-96-01 fax: +39-055-30-09-93

**NIKON AG**  
SWITZERLAND phone: +41-43-277-28-67 fax: +41-43-277-28-61

**NIKON UK LTD.**  
UNITED KINGDOM phone: +44-208-247-1717 fax: +44-208-541-4584

**NIKON GMBH AUSTRIA**  
AUSTRIA phone: +43-1-972-6111-00 fax: +43-1-972-6111-40

**NIKON BELUX**  
BELGIUM phone: +32-2-705-56-65 fax: +32-2-726-66-45